

**Achten Sie beim Ausdrucken (auf DIN A4 Papier) darauf, dass die Zeichnungen nicht verkleinert werden. Legen Sie die Ausdrücke genau nebeneinander (nicht überlappen lassen!) und kleben sie diese mit einem Klebeband aneinander. Die meisten Drucker können nicht bis an den Papierrand drucken, so werden einige Linien nicht bis zum Rand dargestellt werden. Ergänzen Sie diese einfach mit ihrem gesunden Augenmaß. Schneiden Sie anschließend die Außenkontur mit einer Schere aus.**

1

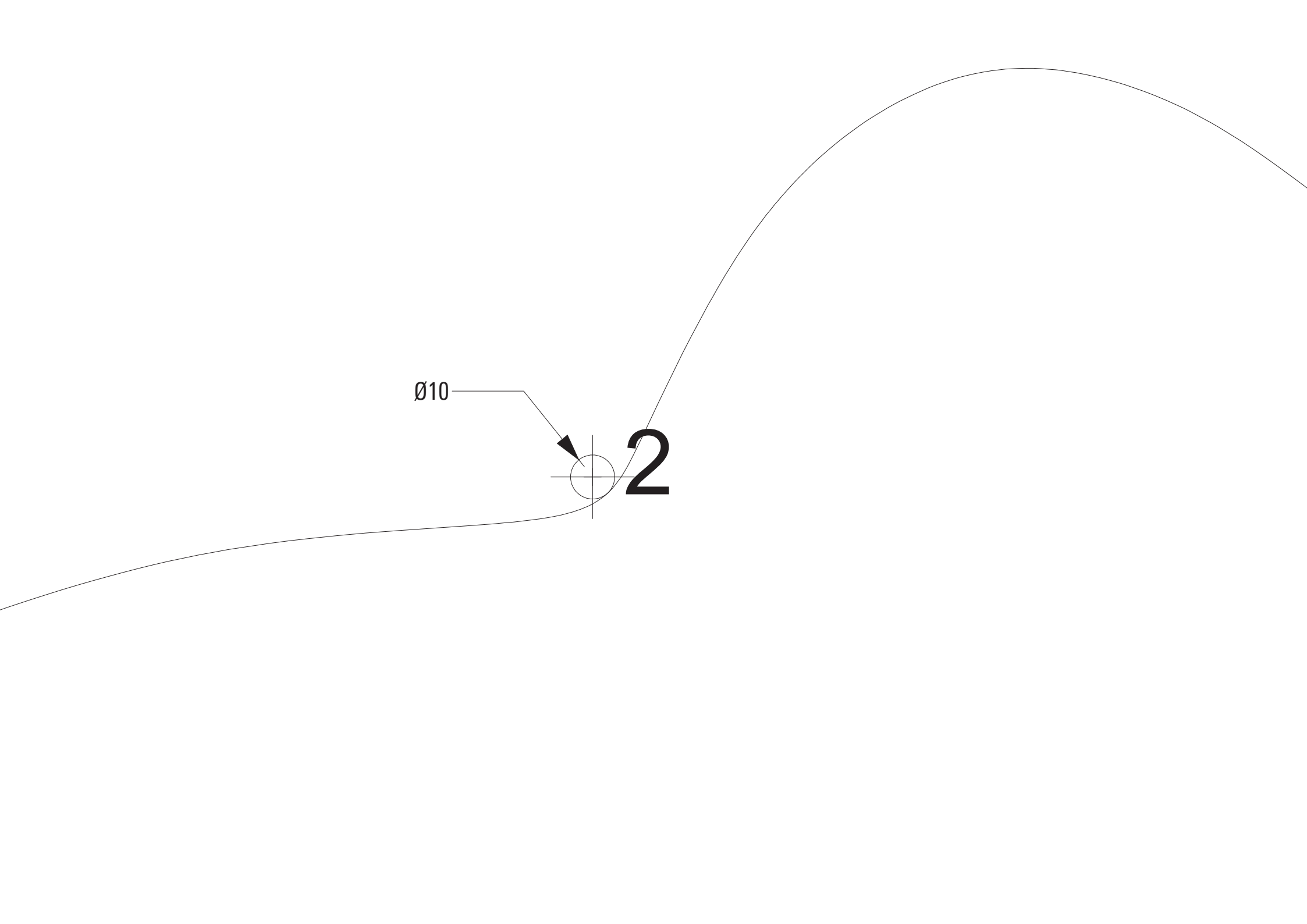

Ø10

2

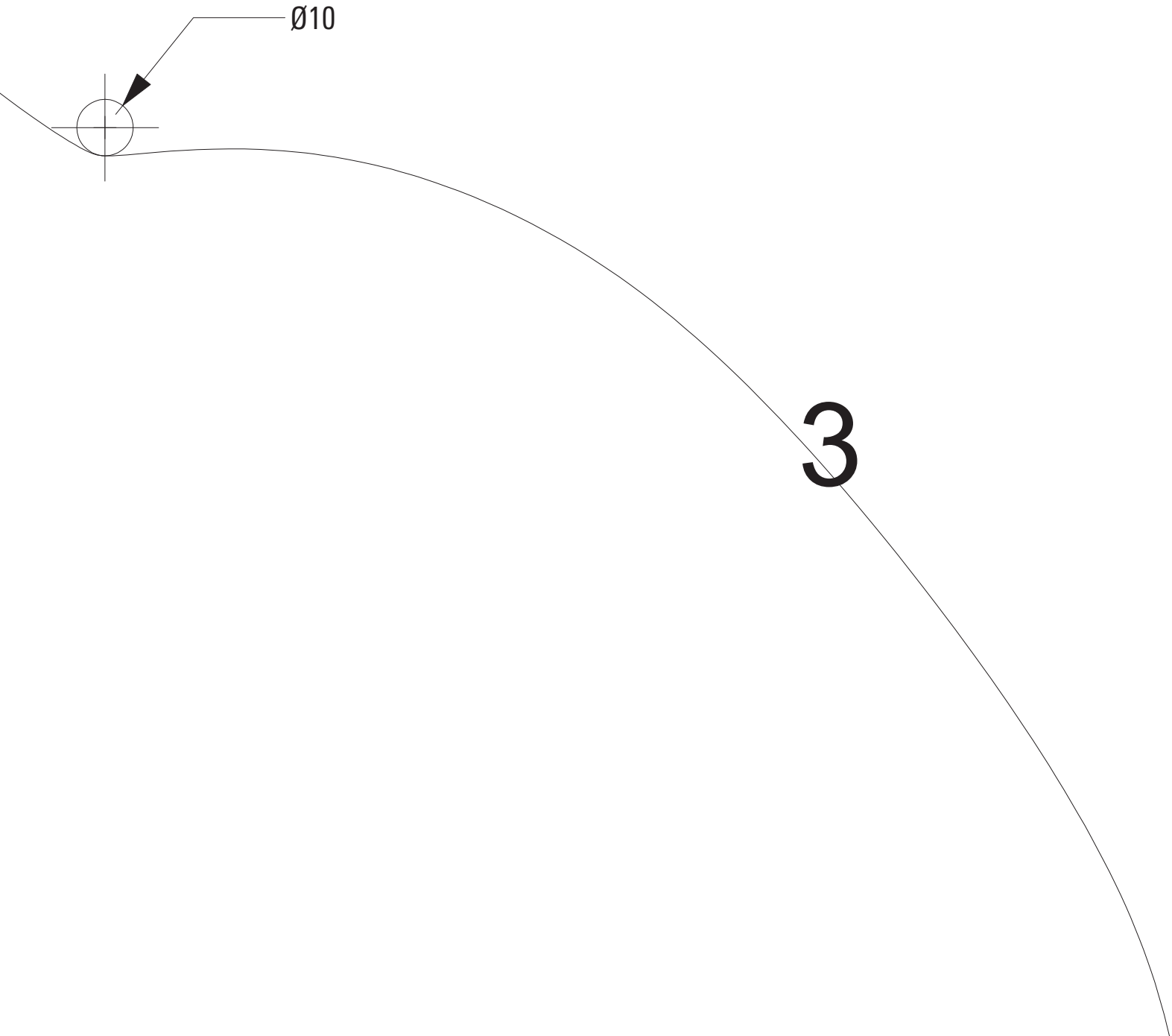

Ø10

3



4

5

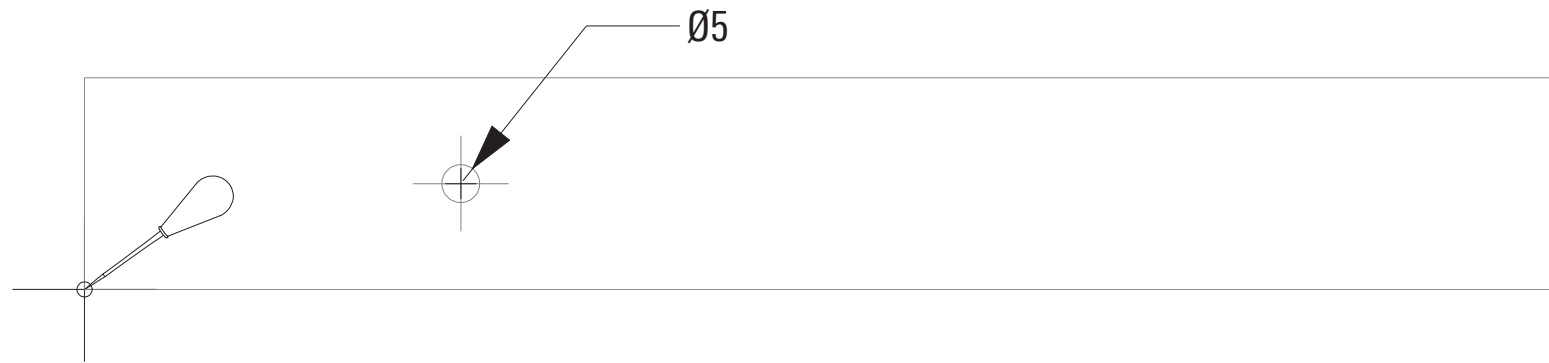

6

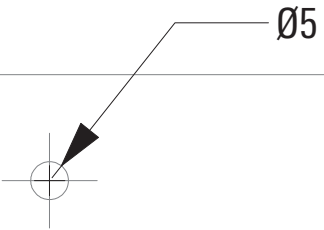
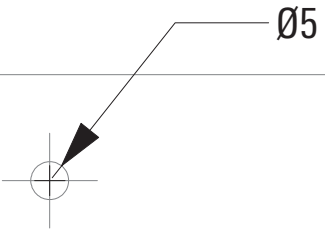

7

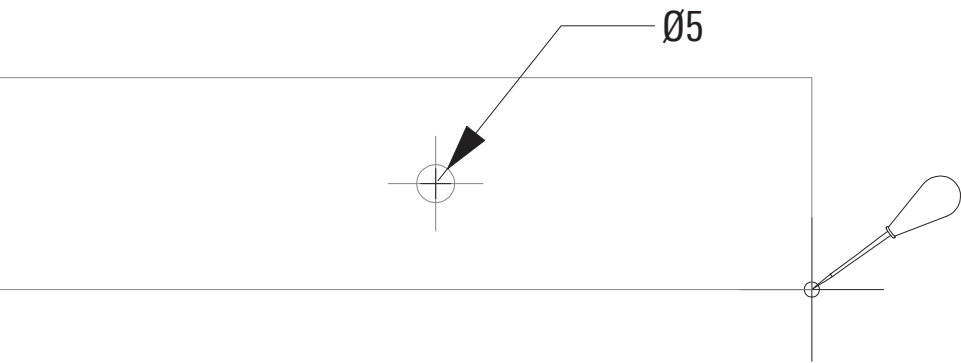

8

Ø10

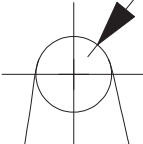

Ø5

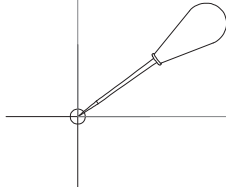



9

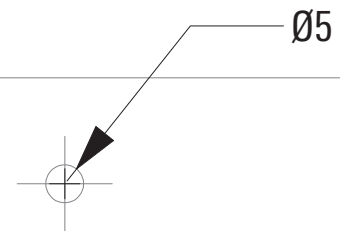
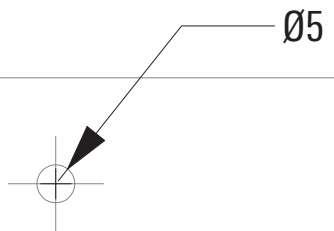

10

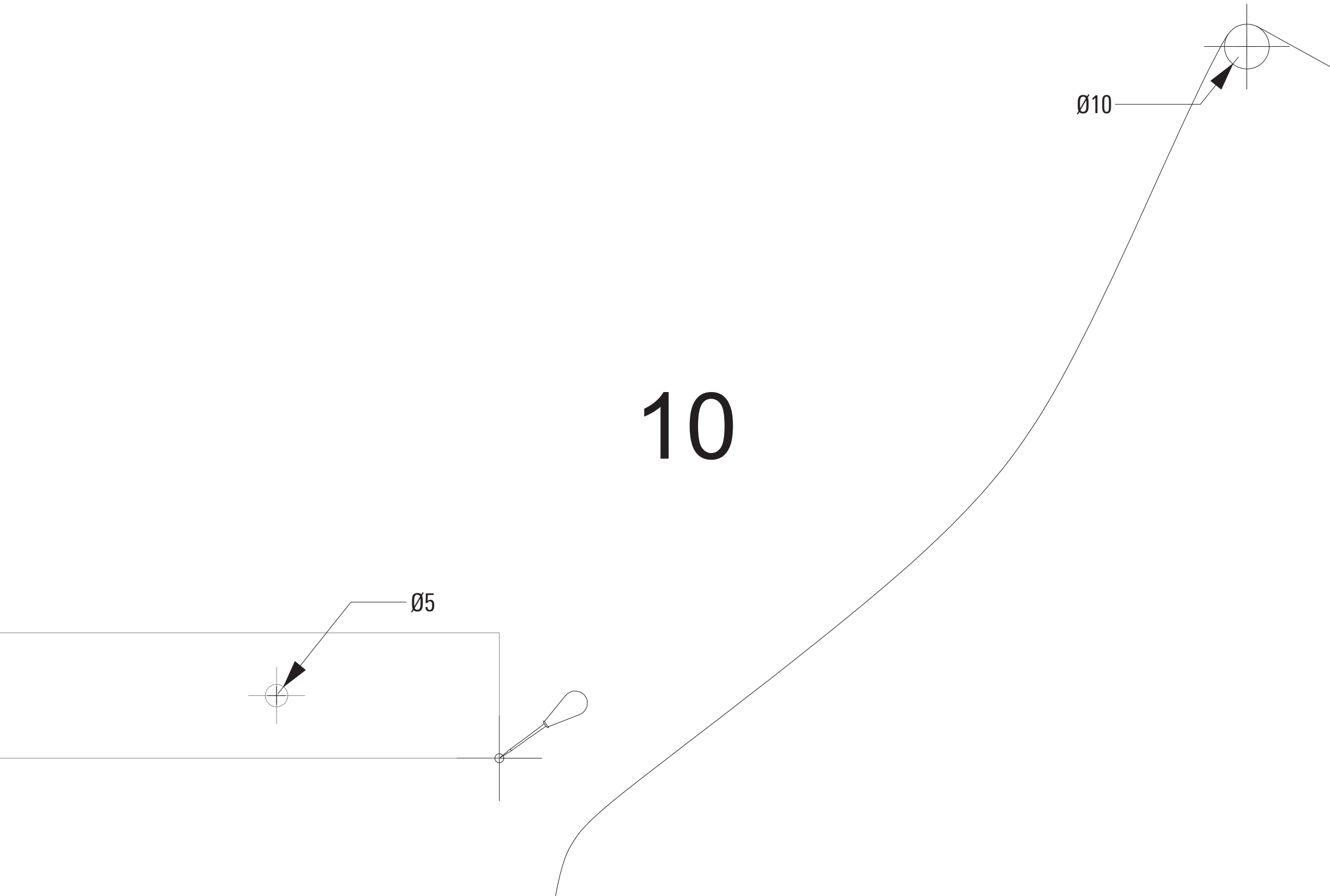

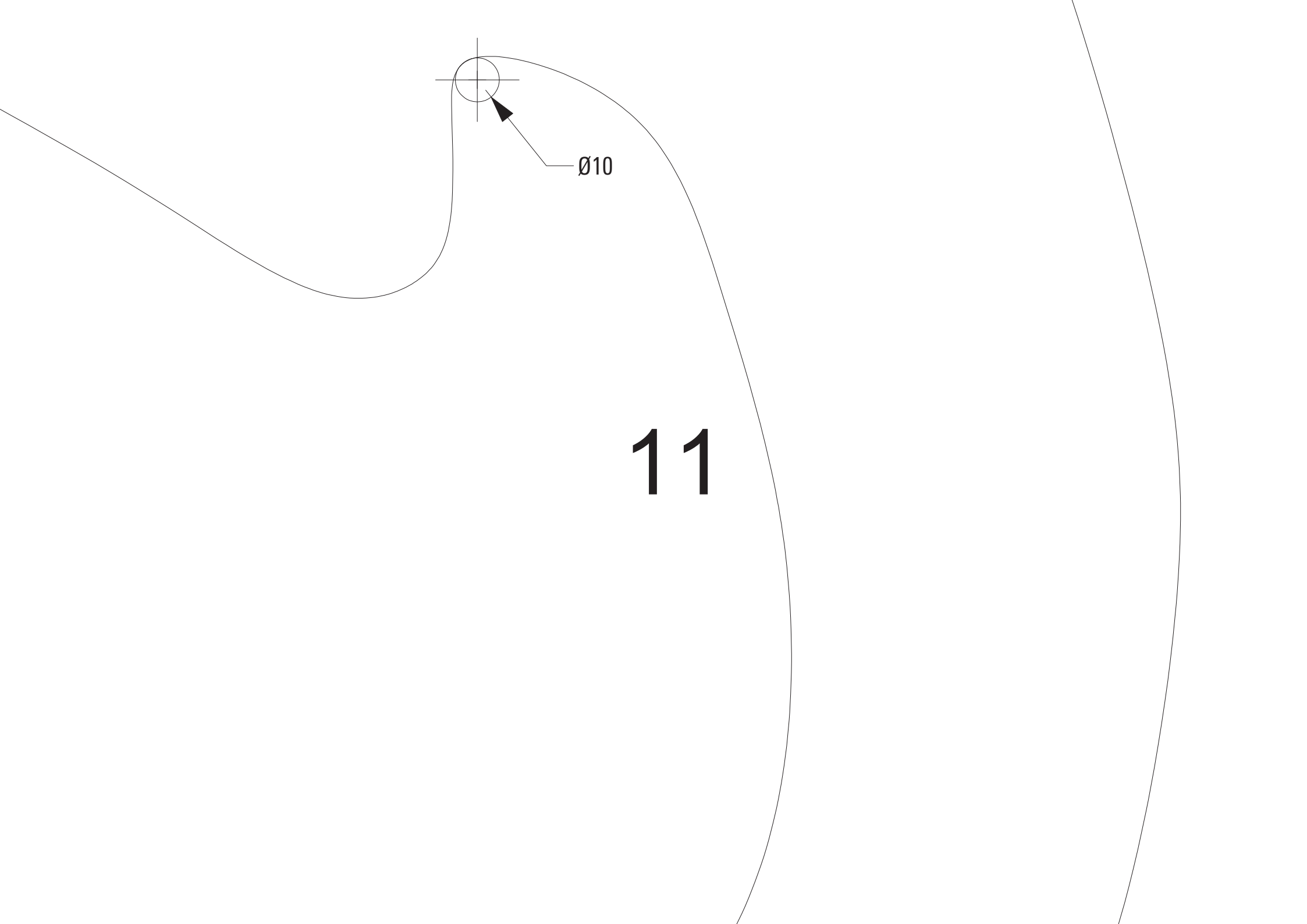

$\varnothing 10$

11

12

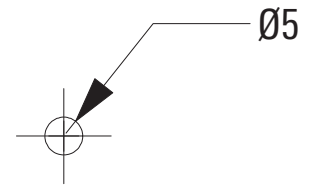

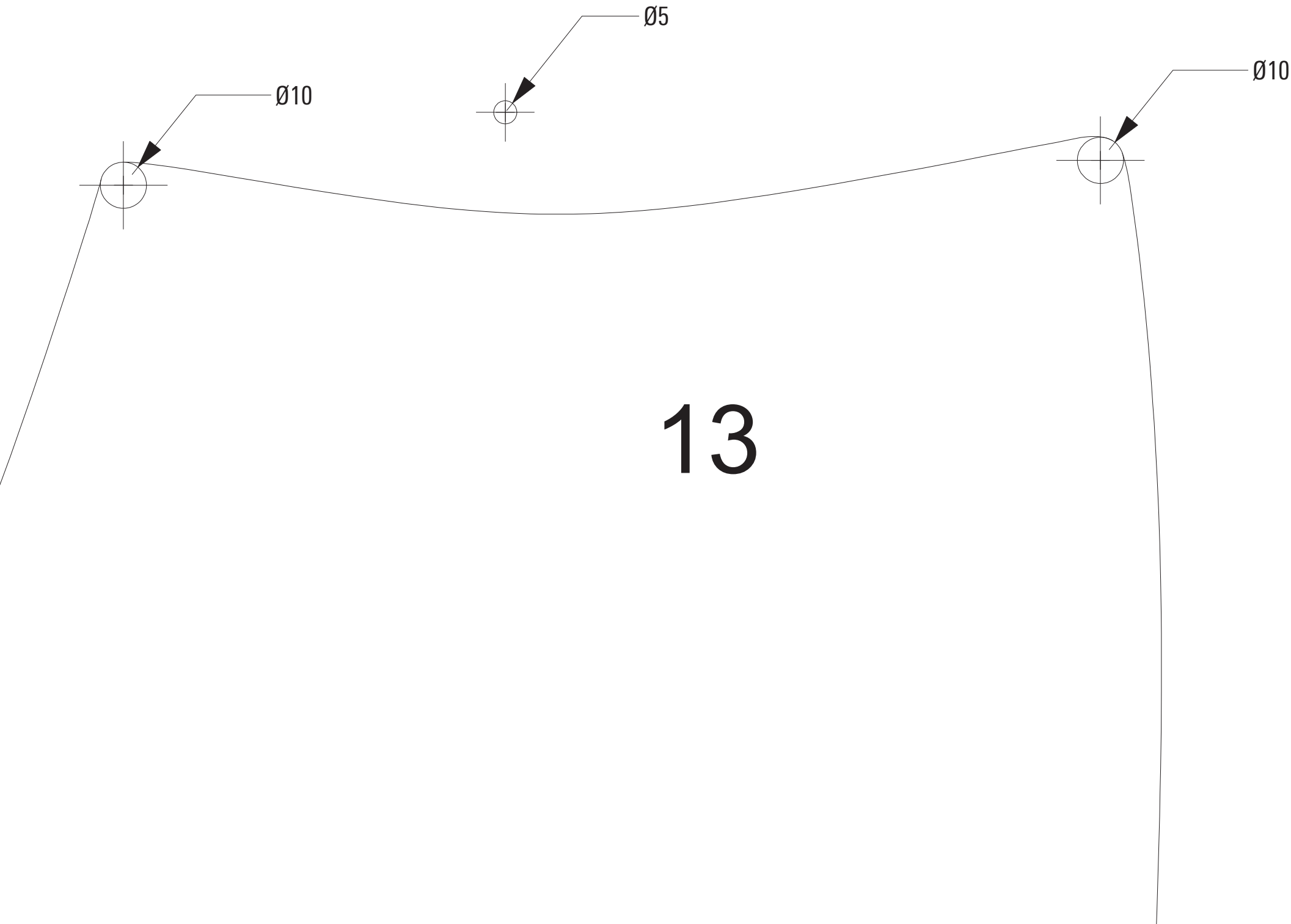

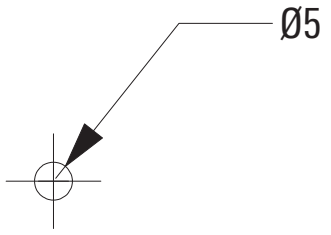

14

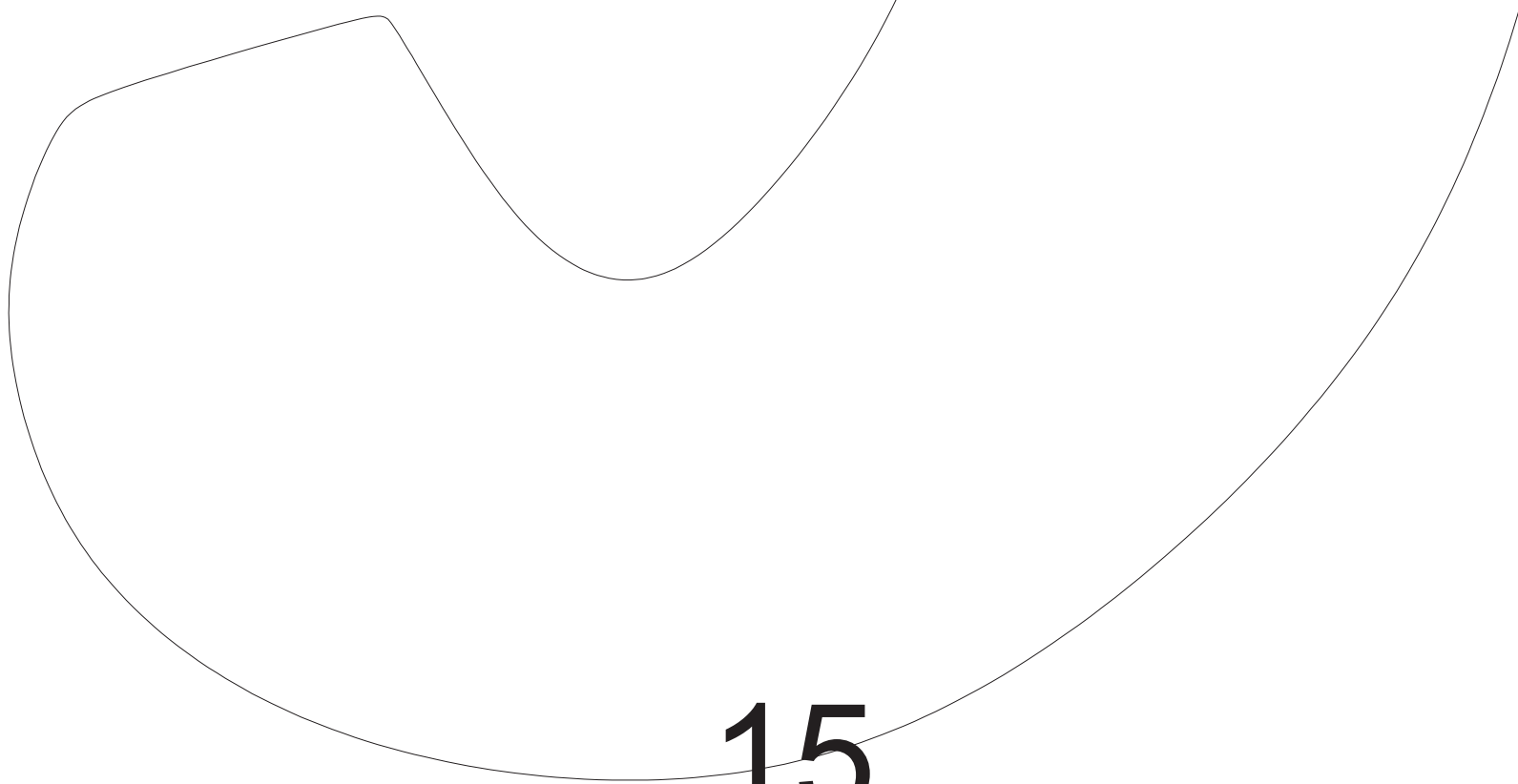

**15**



16



17

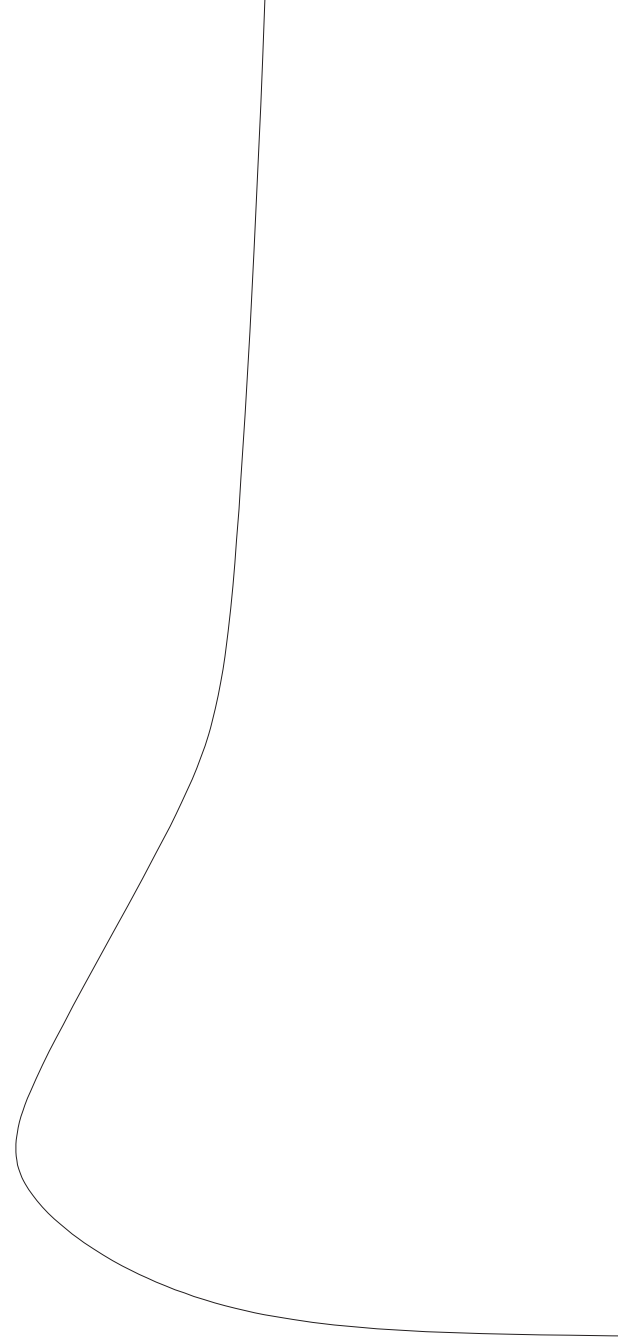



18